



# Alumakor

Composite Wall Systems

## ACM SERIES A1000

## D/BV Dry Seal Rainscreen

---



**RMP**  
Architectural  
Solutions

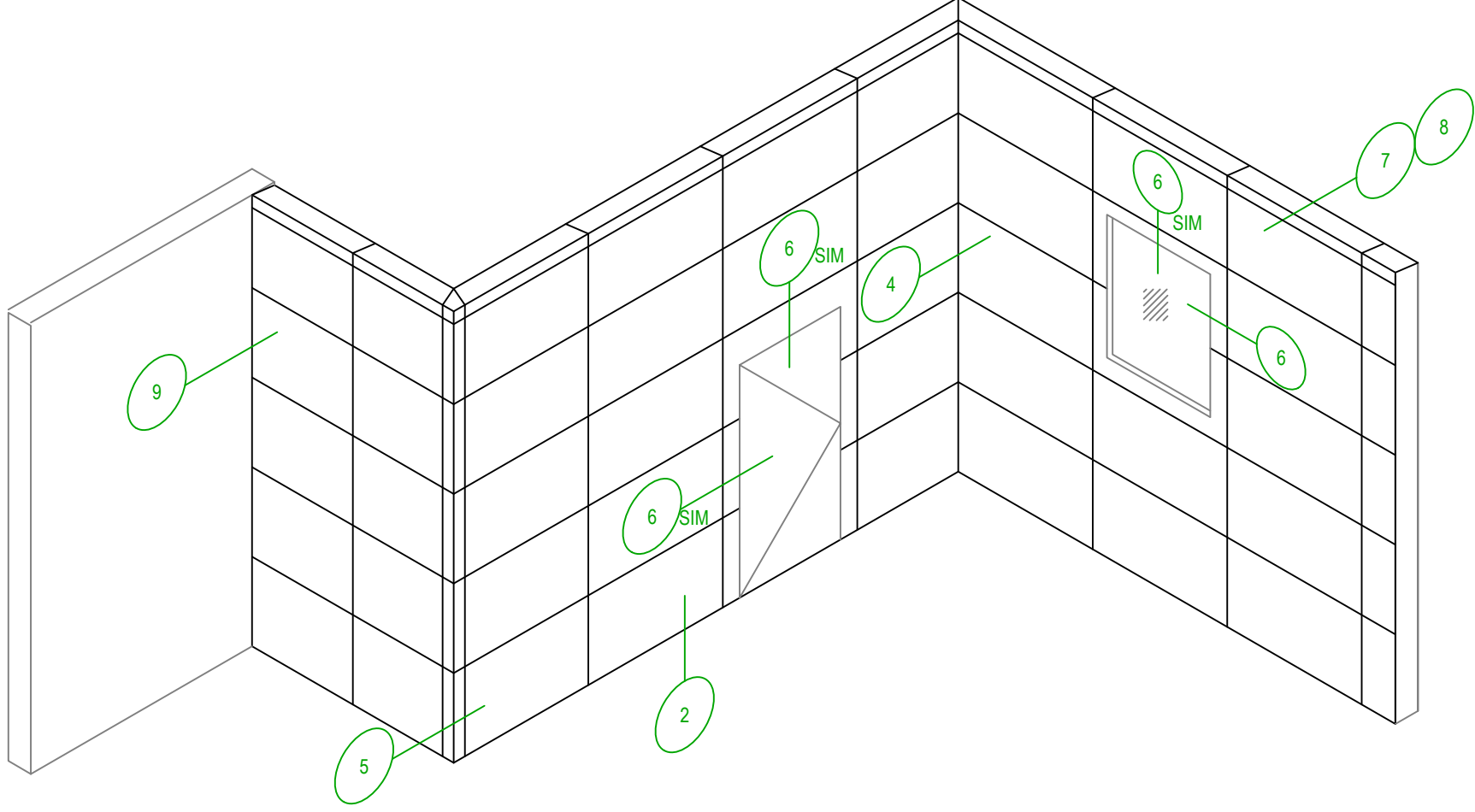

2529 W Jackson St  
 Phoenix AZ 85009  
 PHONE: (602) 275-1676  
 FAX: (602) 275-1739



# ACM DETAIL ELEVATION

SCALE: NTS

7/24/14

SYSTEM = 4MM A1000

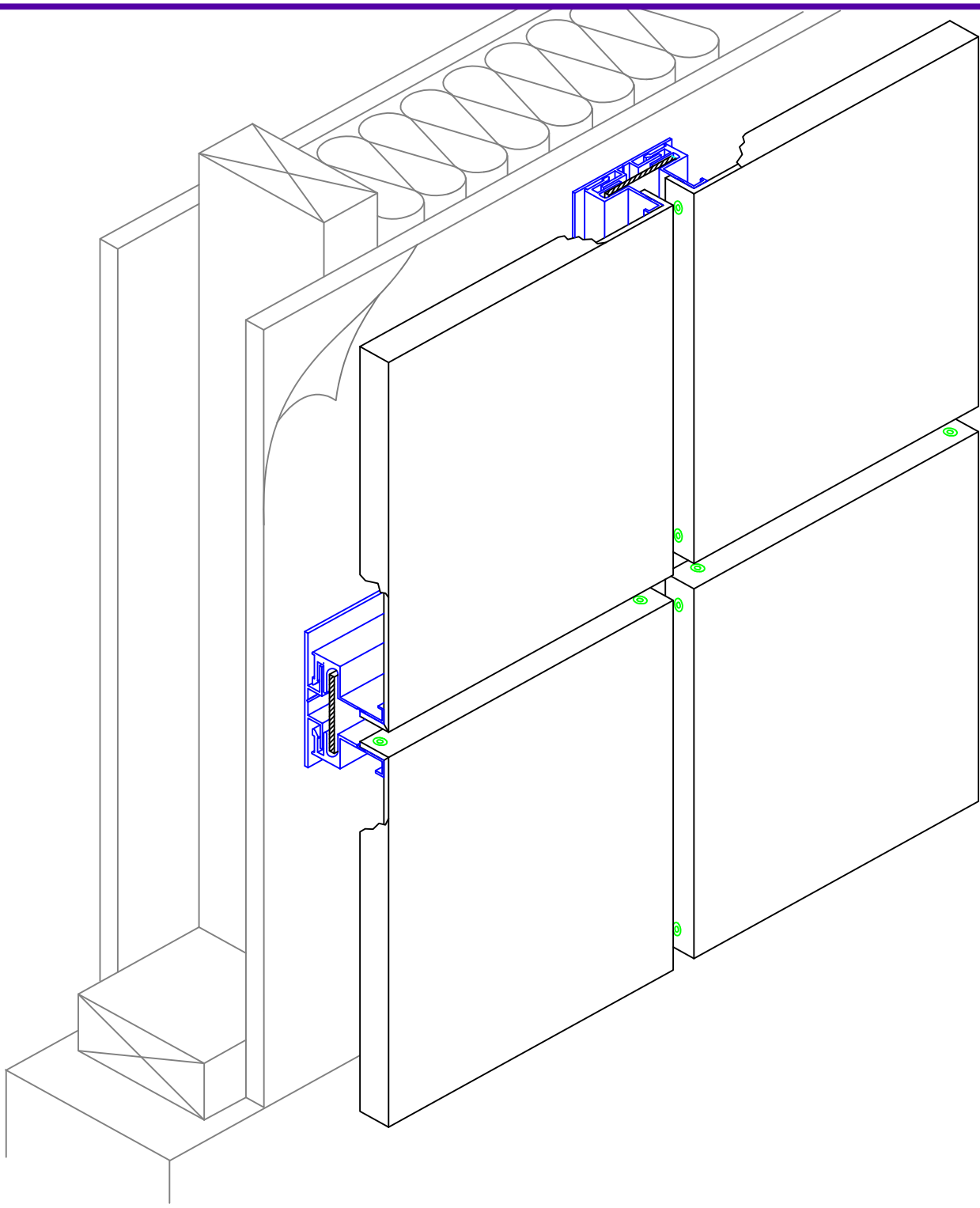

2548 W Jackson St  
Phoenix AZ 85009

PHONE: (602) 275-1676

FAX: (602) 275-1739



# PANEL ISOMETRIC SKETCH

SCALE: NTS

7/24/14

SYSTEM = 4MM A1000

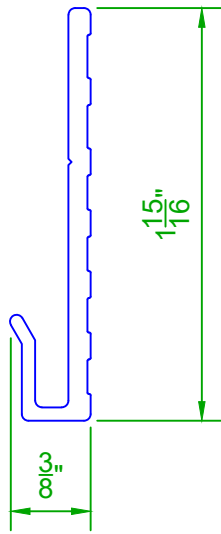

**END CLIP EXTRUSION**

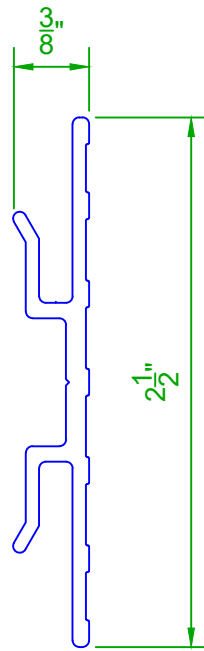

**FIELD CLIP EXTRUSION**

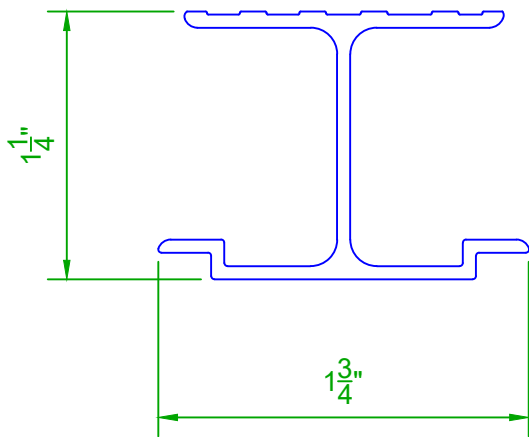

**STIFFENER EXTRUSION**

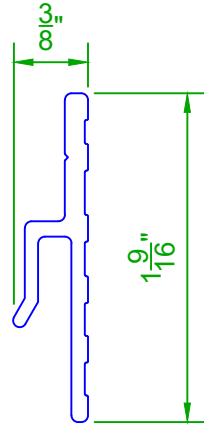

**END CLIP EXTRUSION**

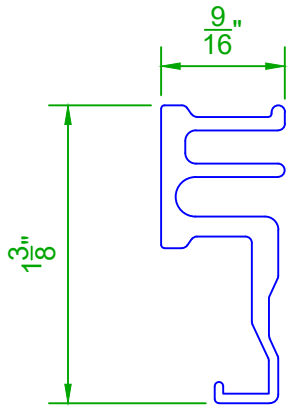

**4MM FRAME EXTRUSION**

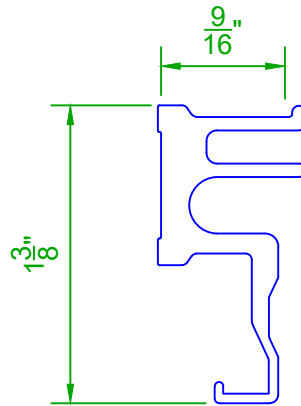

**6MM FRAME EXTRUSION**

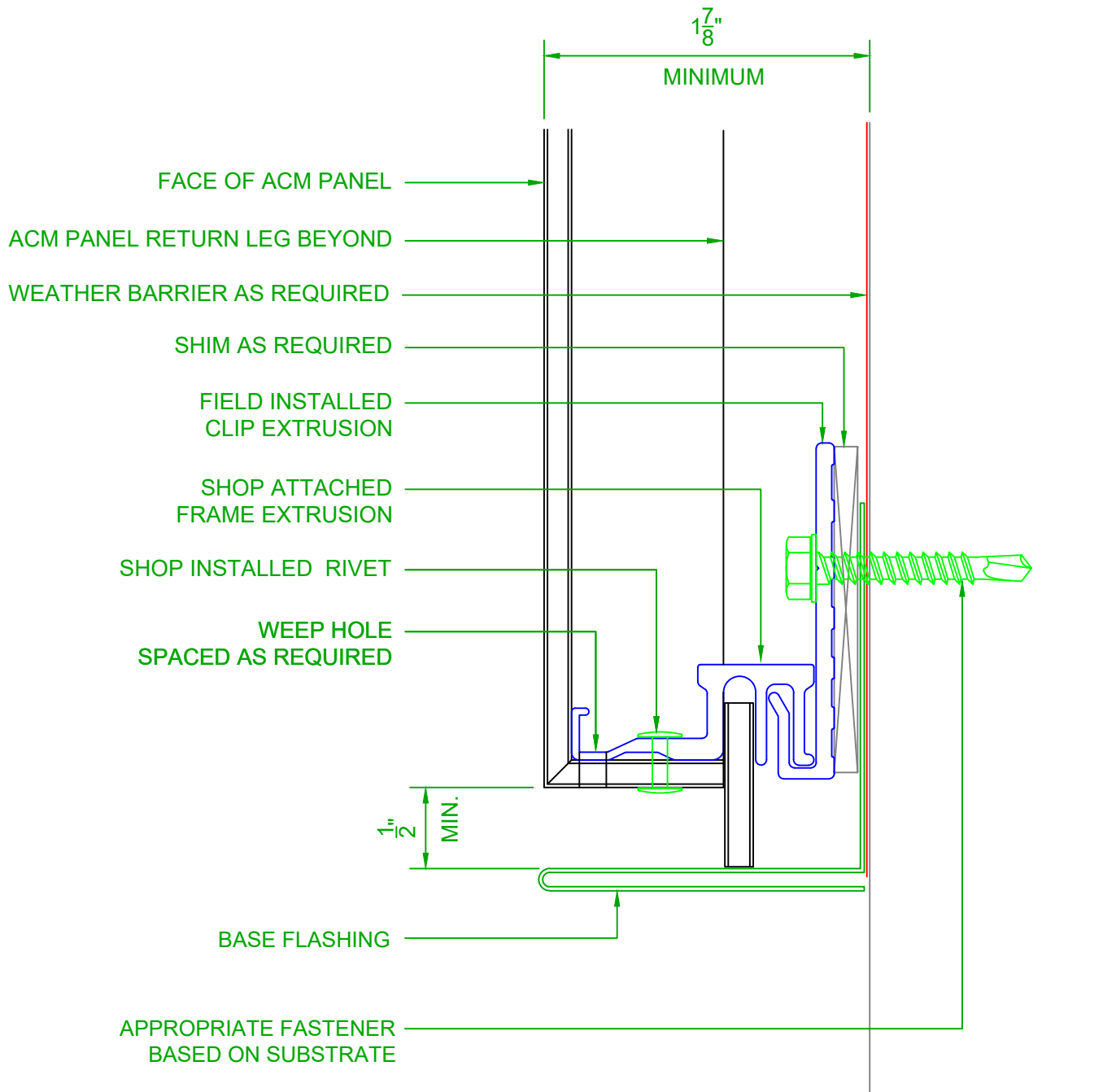

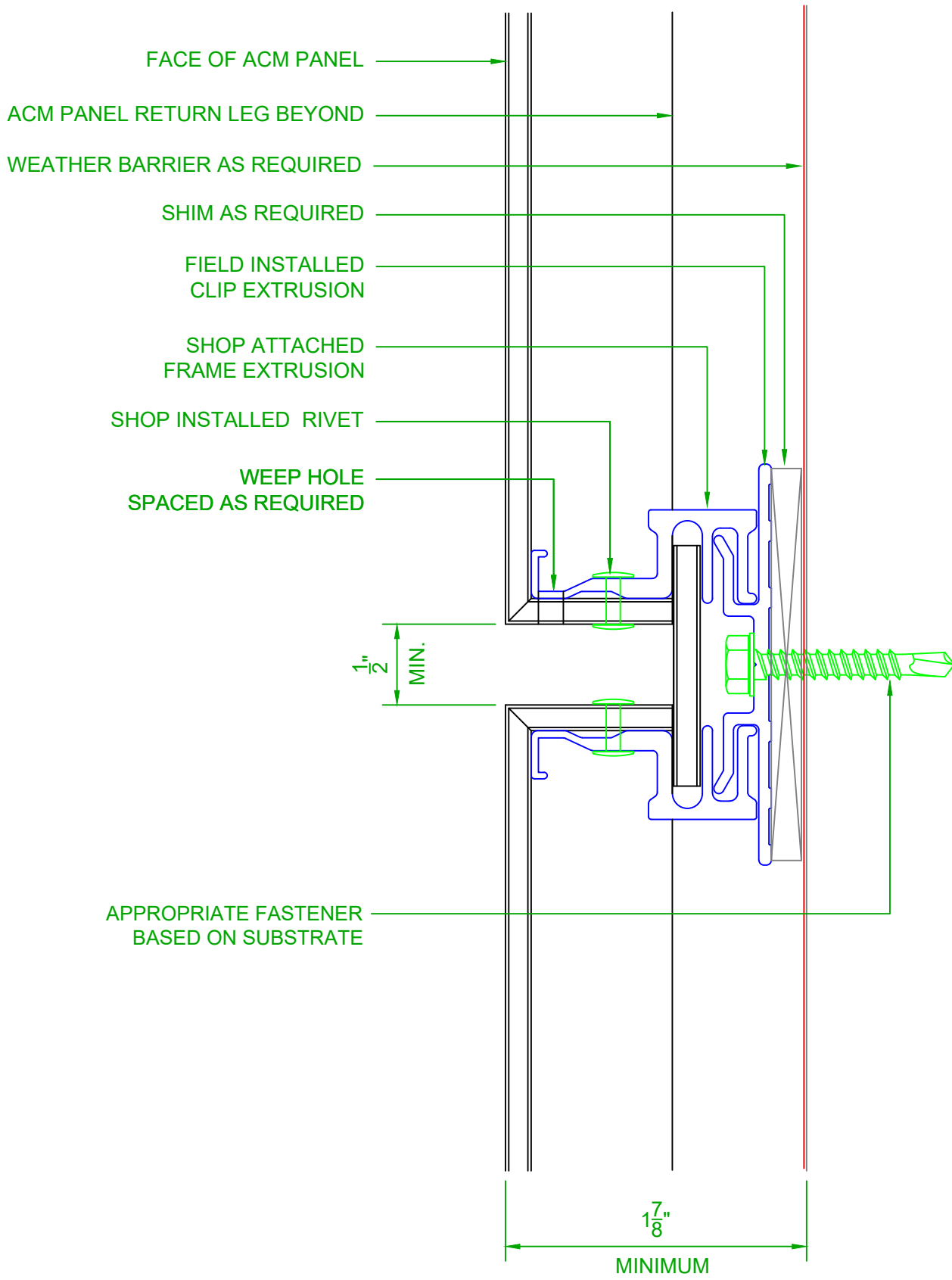

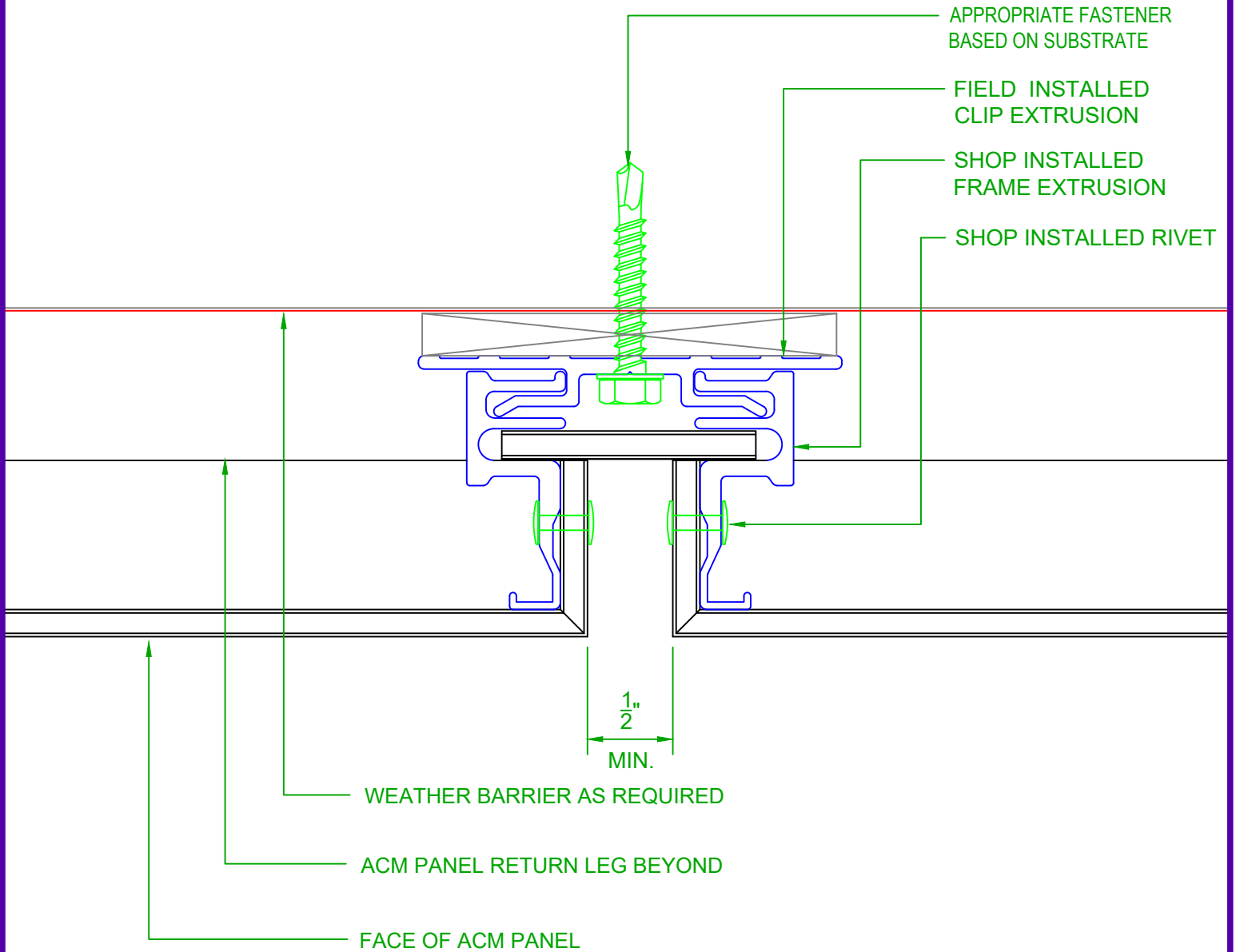

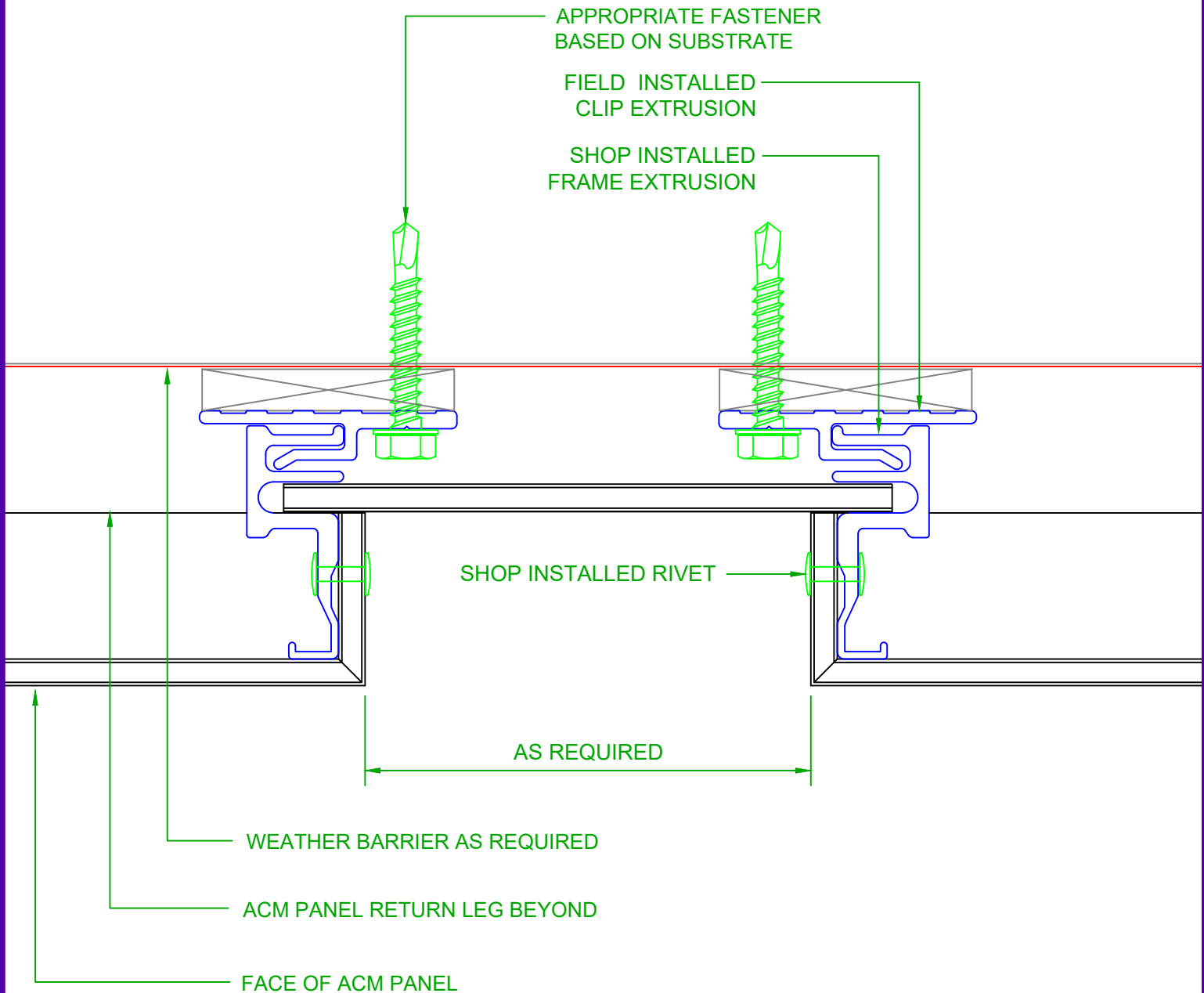



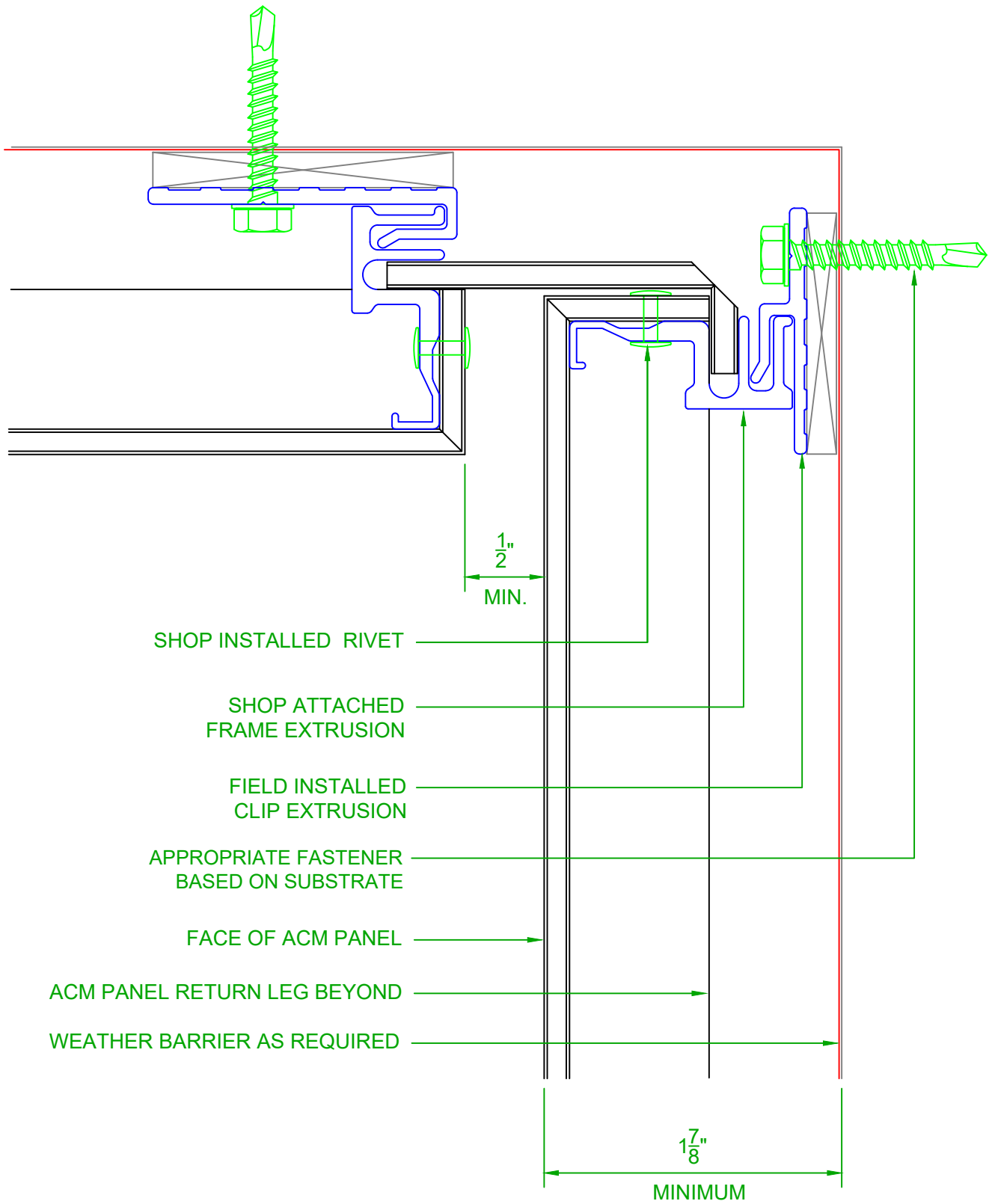

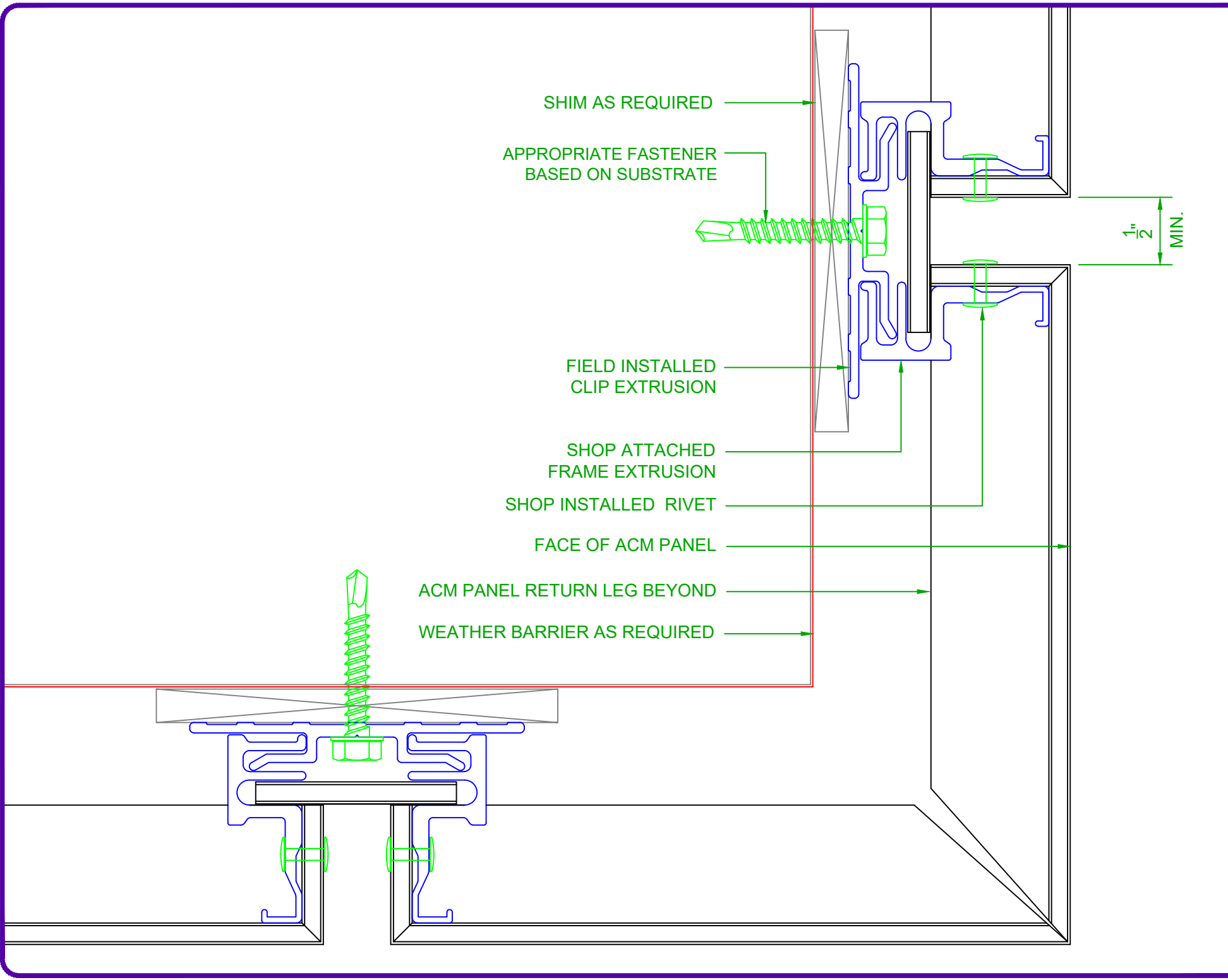

# TYP. OUTSIDE CORNER DETAIL

SCALE: NTS

7/24/14

SYSTEM = 4MM A1000

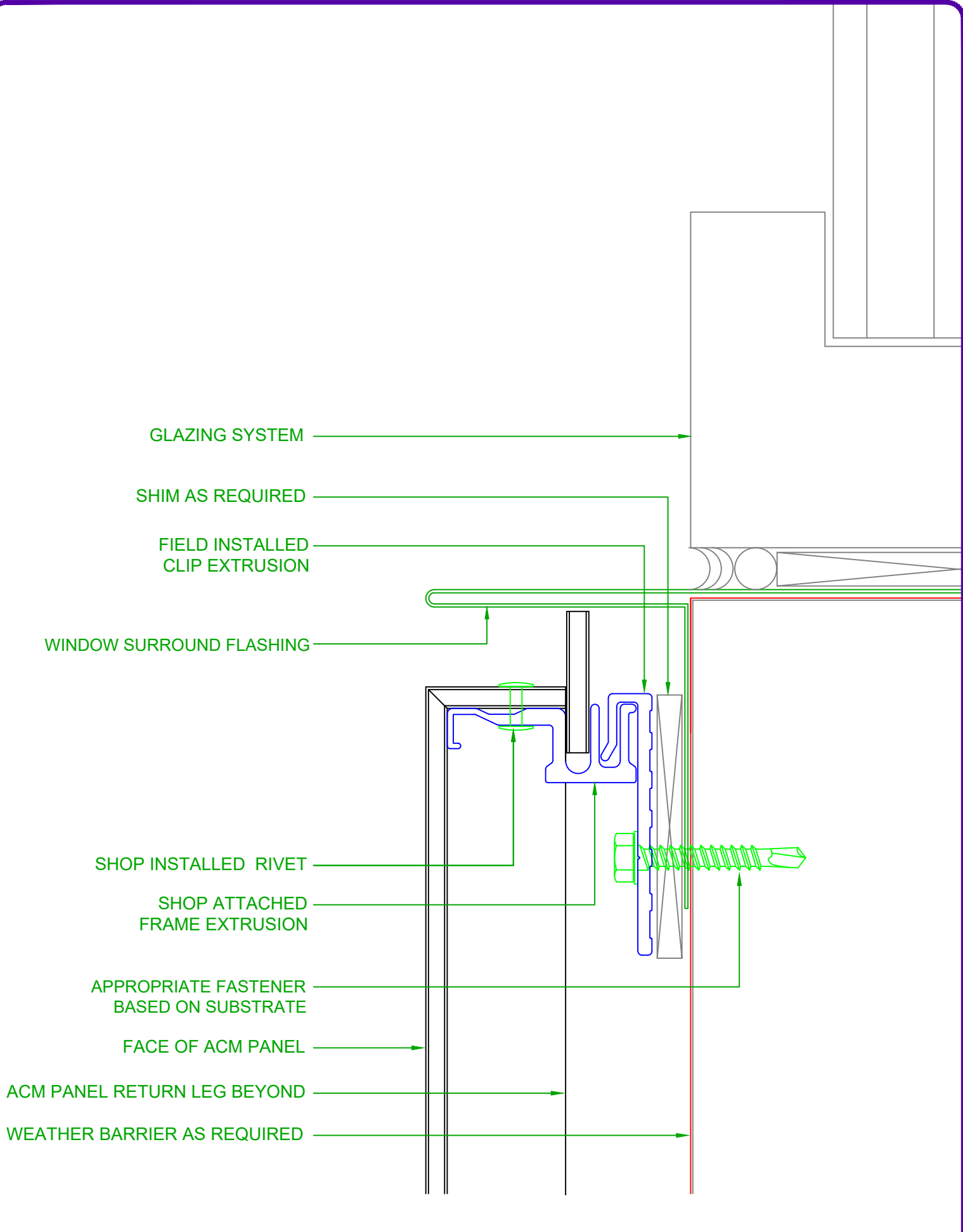

GLAZING SYSTEM

SHIM AS REQUIRED

FIELD INSTALLED  
CLIP EXTRUSION

WINDOW SURROUND FLASHING

SHOP INSTALLED RIVET

SHOP ATTACHED  
FRAME EXTRUSION

APPROPRIATE FASTENER  
BASED ON SUBSTRATE

FACE OF ACM PANEL

ACM PANEL RETURN LEG BEYOND

WEATHER BARRIER AS REQUIRED

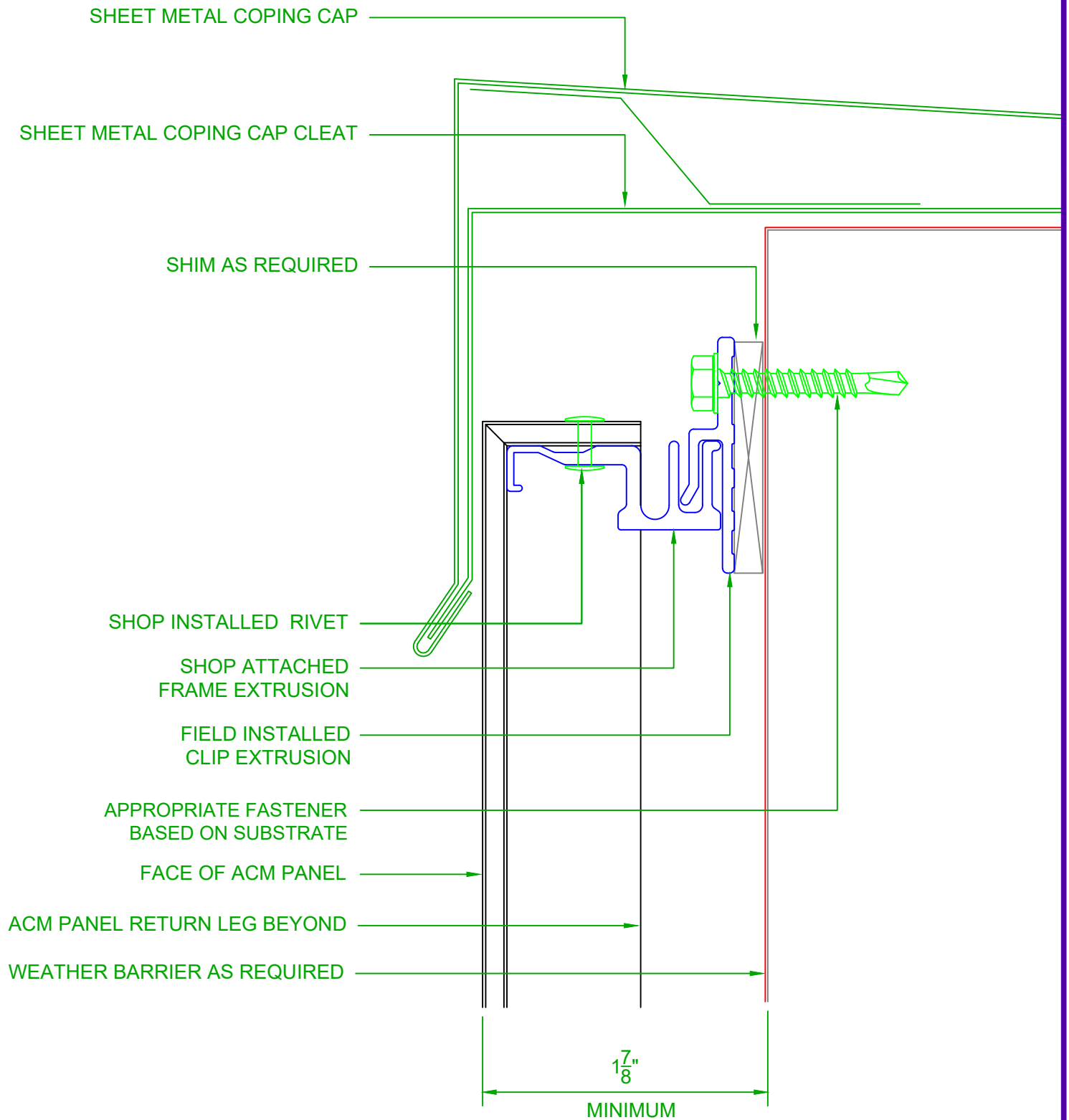

# TYP. ACM COPING CAP DETAIL

SYSTEM = 4MM A1000

7/24/14

SCALE: NTS

2548 W Jackson  
Phoenix AZ 85009  
PHONE: (602) 275-1676  
FAX: (602) 275-1739

