

2529 W. Jackson St.
 Phoenix, AZ 85298
 PHONE: (602) 275-1676
 FAX: (602) 275-1739



ALUMINUM DETAIL ELEVATION

SCALE: NTS

7/24/14

SYSTEM = 1/8" ALUMINUM - AP400

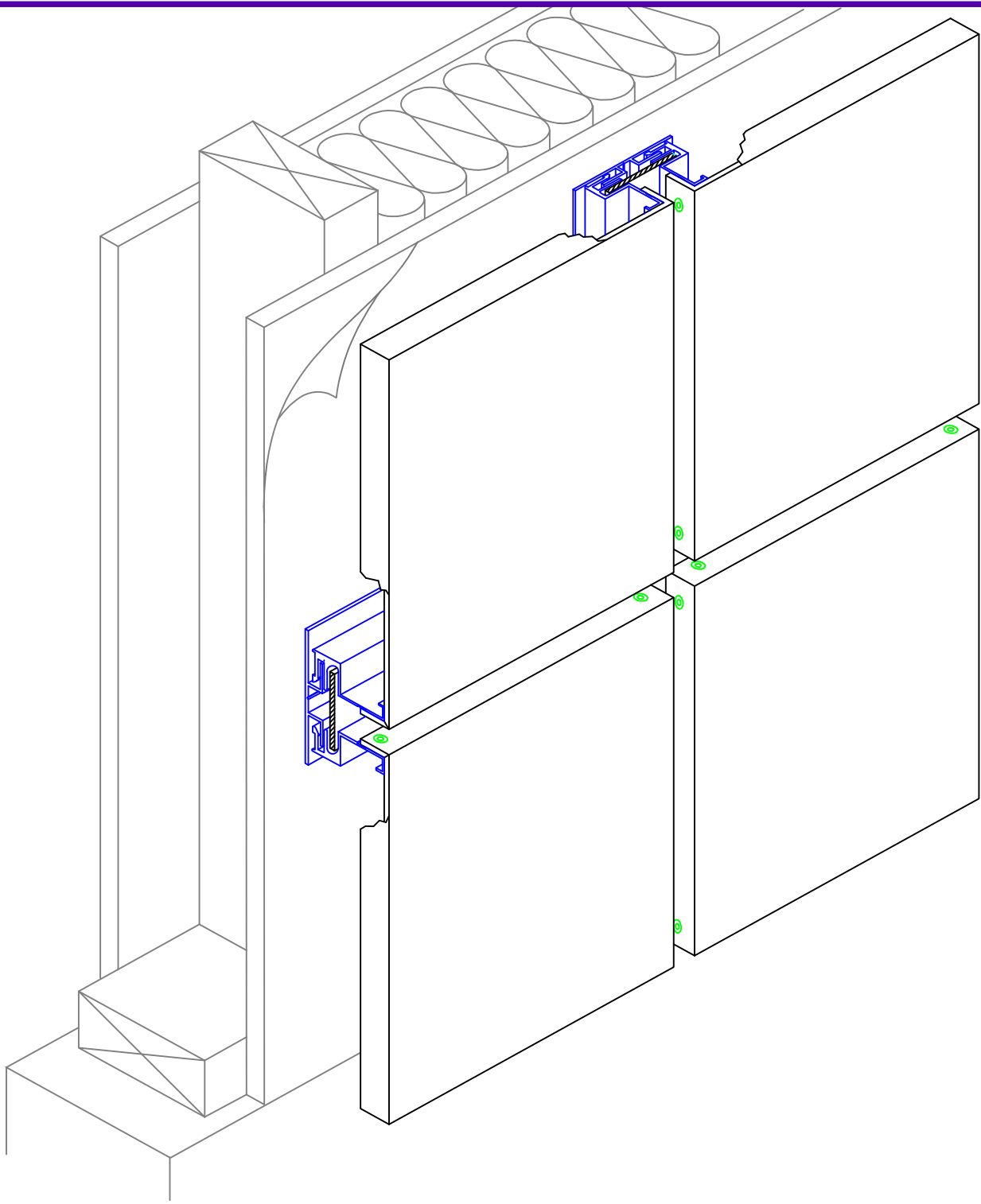

2529 W. Jackson St.
Phoenix, AZ 85298
PHONE: (602) 275-1676
FAX: (602) 275-1739



PANEL ISOMETRIC SKETCH

SCALE: NTS

7/24/14

SYSTEM = 1/8" ALUMINUM - AP400

0

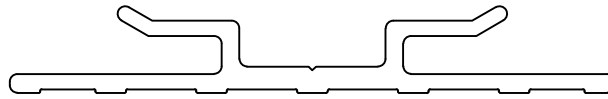

FIELD CLIP EXTRUSION

FIELD OR SHOP CUT TO 6", FIELD MOUNTED
TO SUBSTRATE @ 16" O.C.

W/ 2 - #10 / #12 x 1 1/2" SELF TAPPING STAINLESS SCREWS
APPLY SHIMS BENEATH AS REQUIRED



MODIFIED CLIP EXTRUSION

FIELD CUT TO FIT AS REQUIRED
MOUNTED IN FULL LENGTH SECTIONS @ 16" O.C.
CAN BE USED AT: STARTER, JAMB, SILL, END WALL
#10 / #12 X 1 1/2" SELF TAPPING STAINLESS SCREW



SILL CLIP EXTRUSION

FIELD CUT TO FIT AS REQUIRED
MOUNTED IN FULL LENGTH SECTIONS @ 16" O.C.
CAN BE USED AT: STARTER, JAMB, SILL
#10 / #12 X 1 1/2" SELF TAPPING STAINLESS SCREW

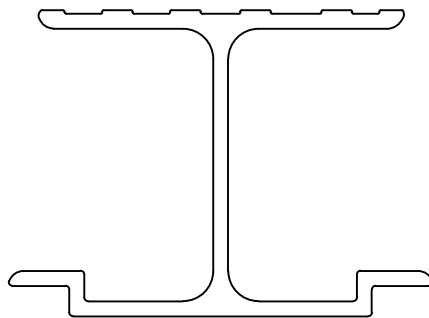

STIFFENER EXTRUSION

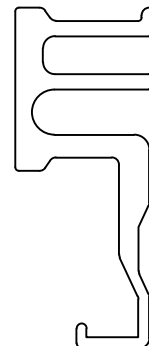

FRAME EXTRUSION

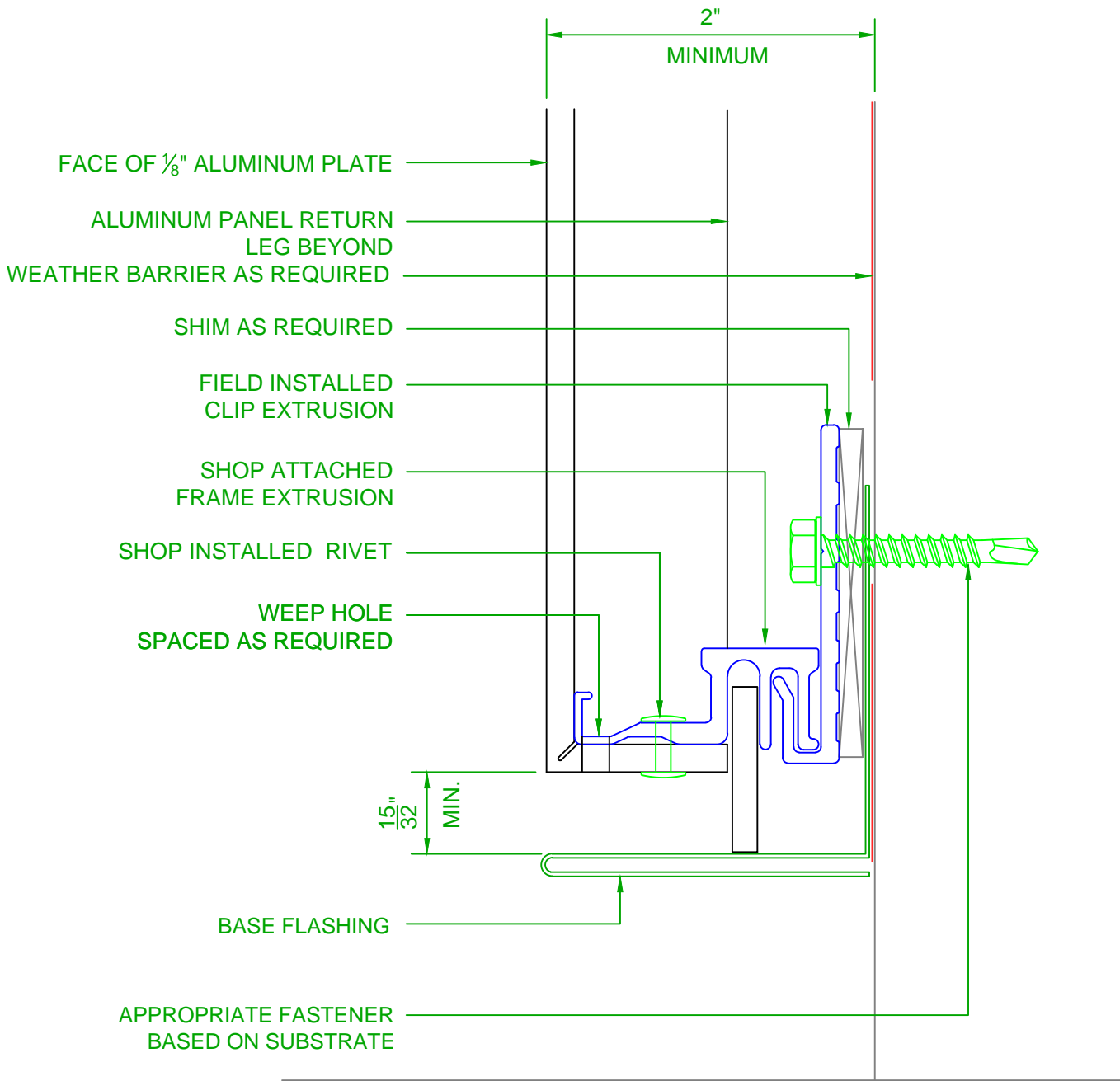

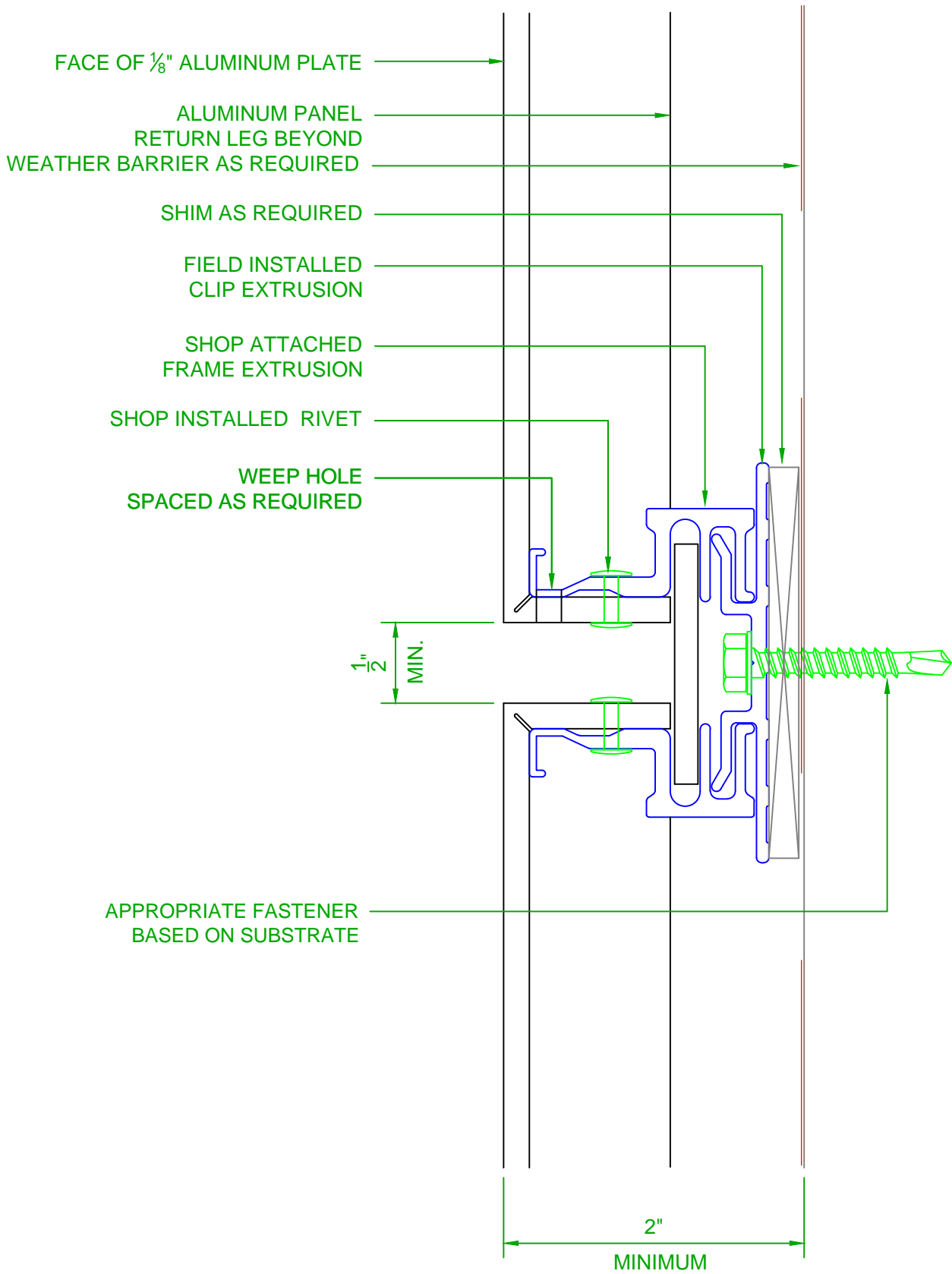

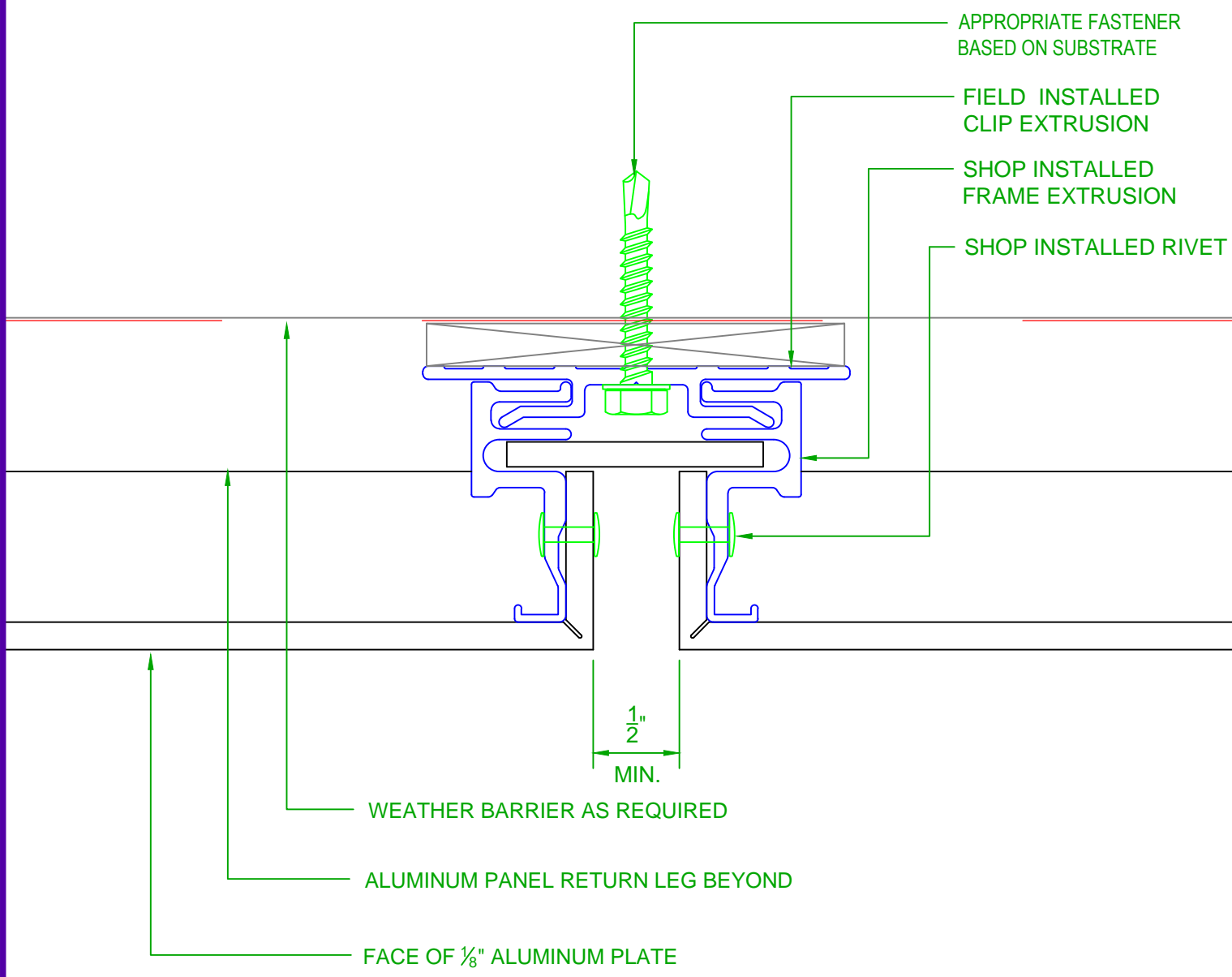

APPROPRIATE FASTENER
 BASED ON SUBSTRATE
 FIELD INSTALLED
 CLIP EXTRUSION
 SHOP INSTALLED
 FRAME EXTRUSION
 SHOP INSTALLED RIVET
 WEATHER BARRIER AS REQUIRED
 ALUMINUM PANEL RETURN LEG BEYOND
 FACE OF 1/8" ALUMINUM PLATE

$\frac{1}{2}$ "
 MIN.



2529 W. Jackson St.
 Phoenix, AZ 85298
 PHONE: (602) 275-1676
 FAX: (602) 275-1739

TYP VERTICAL REVEAL

3A

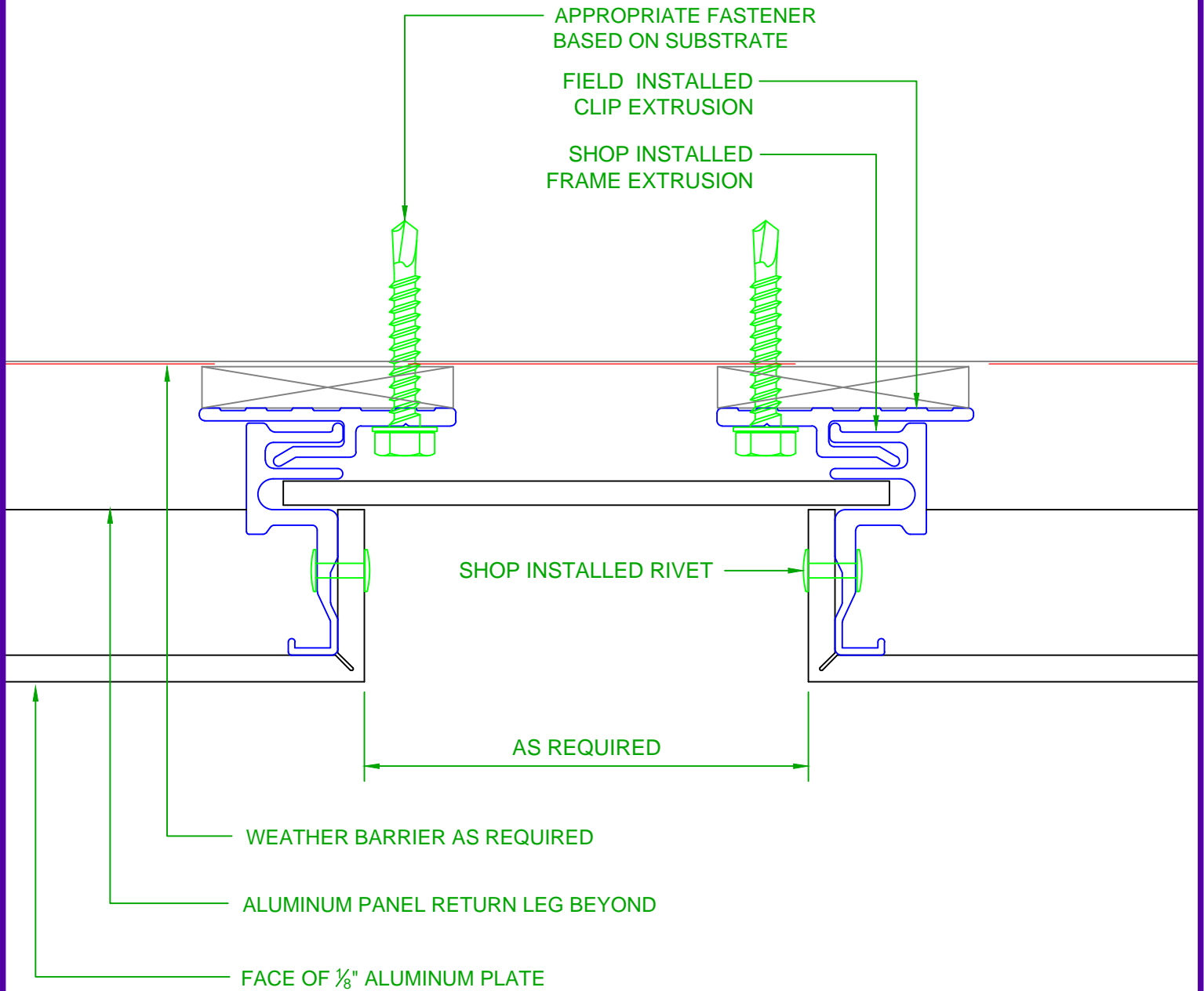

2529 W. Jackson St.
Phoenix, AZ 85298
PHONE: (602) 275-1676
FAX: (602) 275-1739

ALTERNATE REVEAL

SCALE: NTS

7/24/14

SYSTEM = 1/8" ALUMINUM - AP400

3B

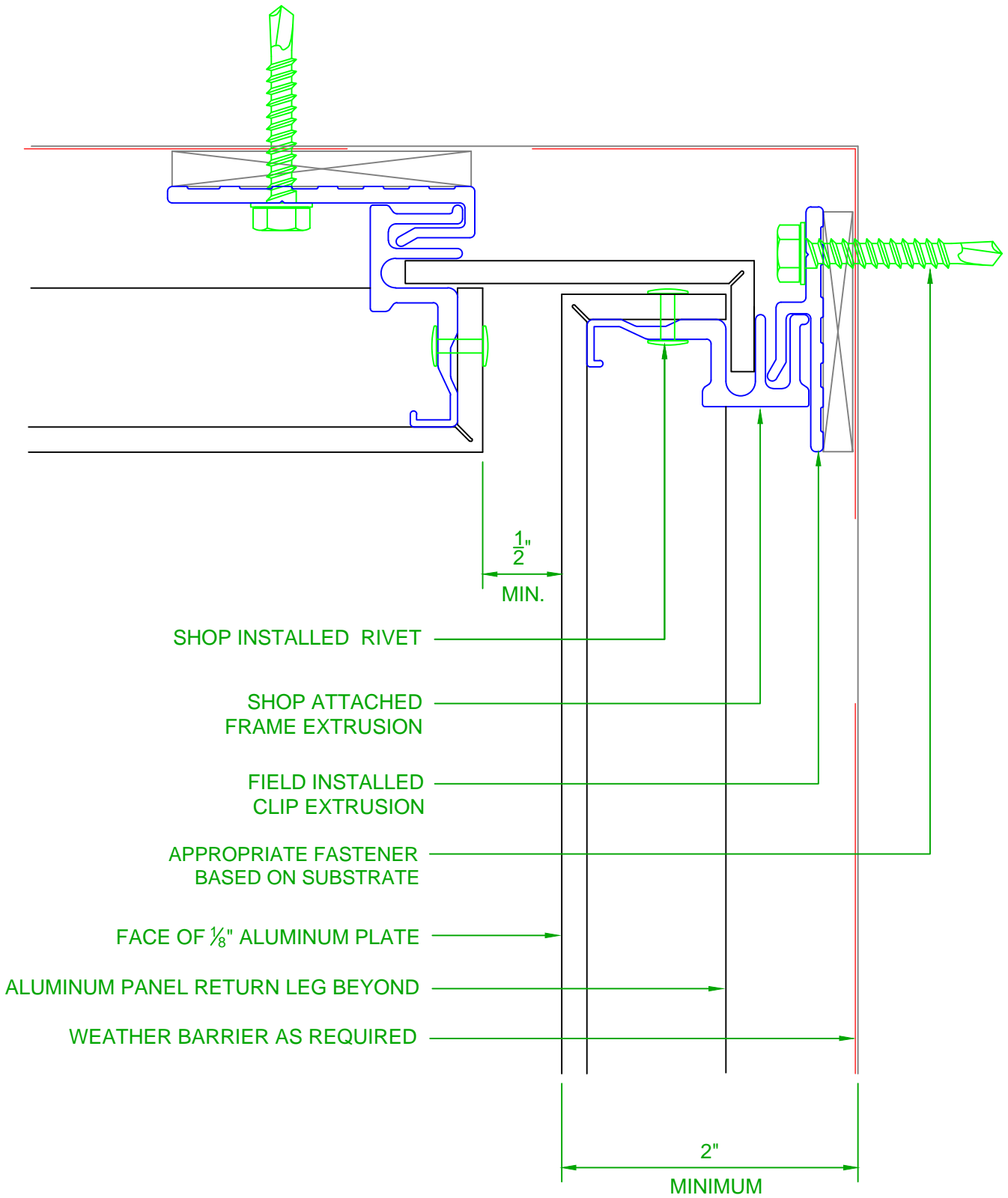

TYP. OUTSIDE CORNER DETAIL

SYSTEM = 1/8" ALUMINUM - AP400

7/24/14

SCALE: NTS

2529 W. Jackson St.
Phoenix, AZ 85298
PHONE: (602) 275-1676
FAX: (602) 275-1739

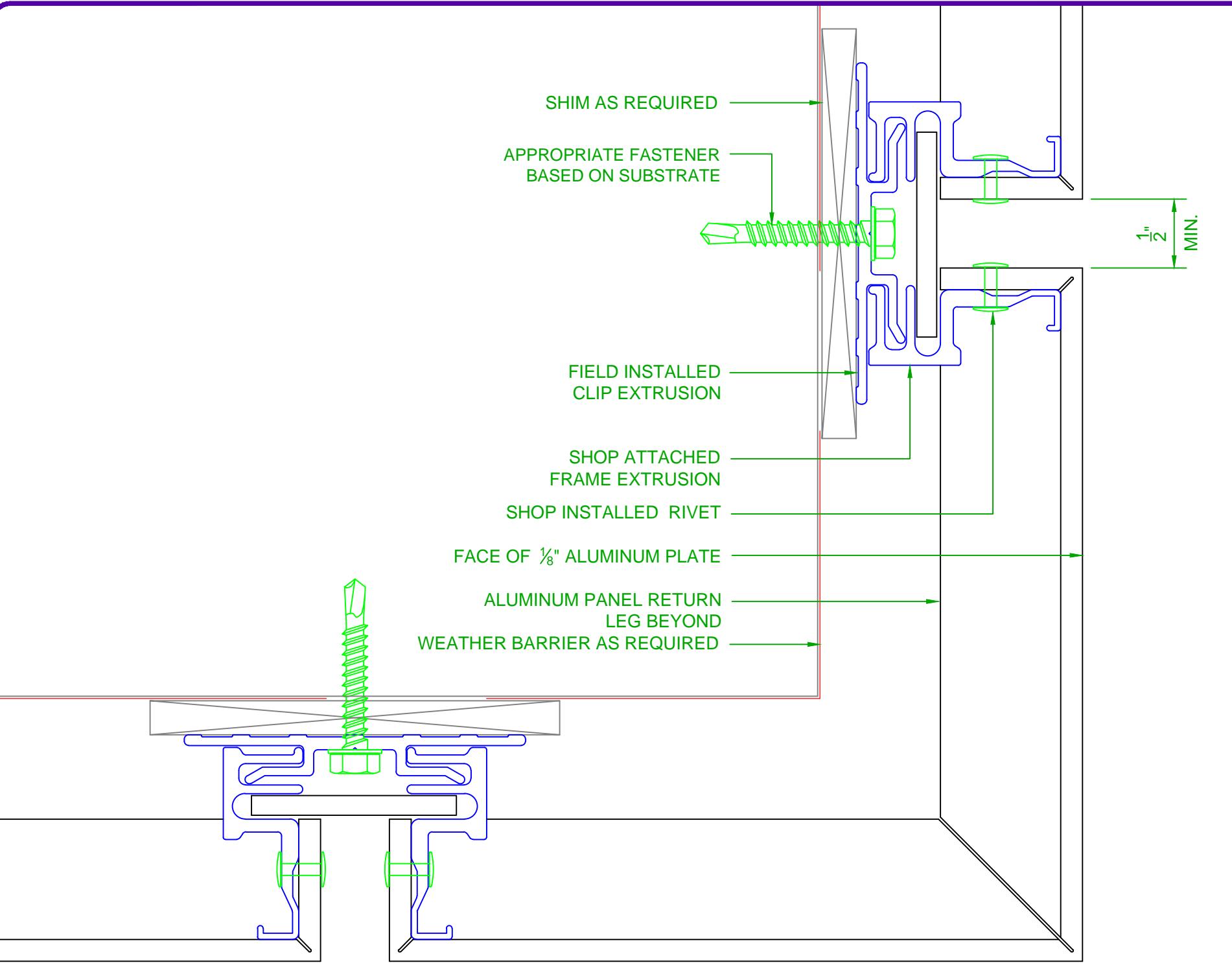

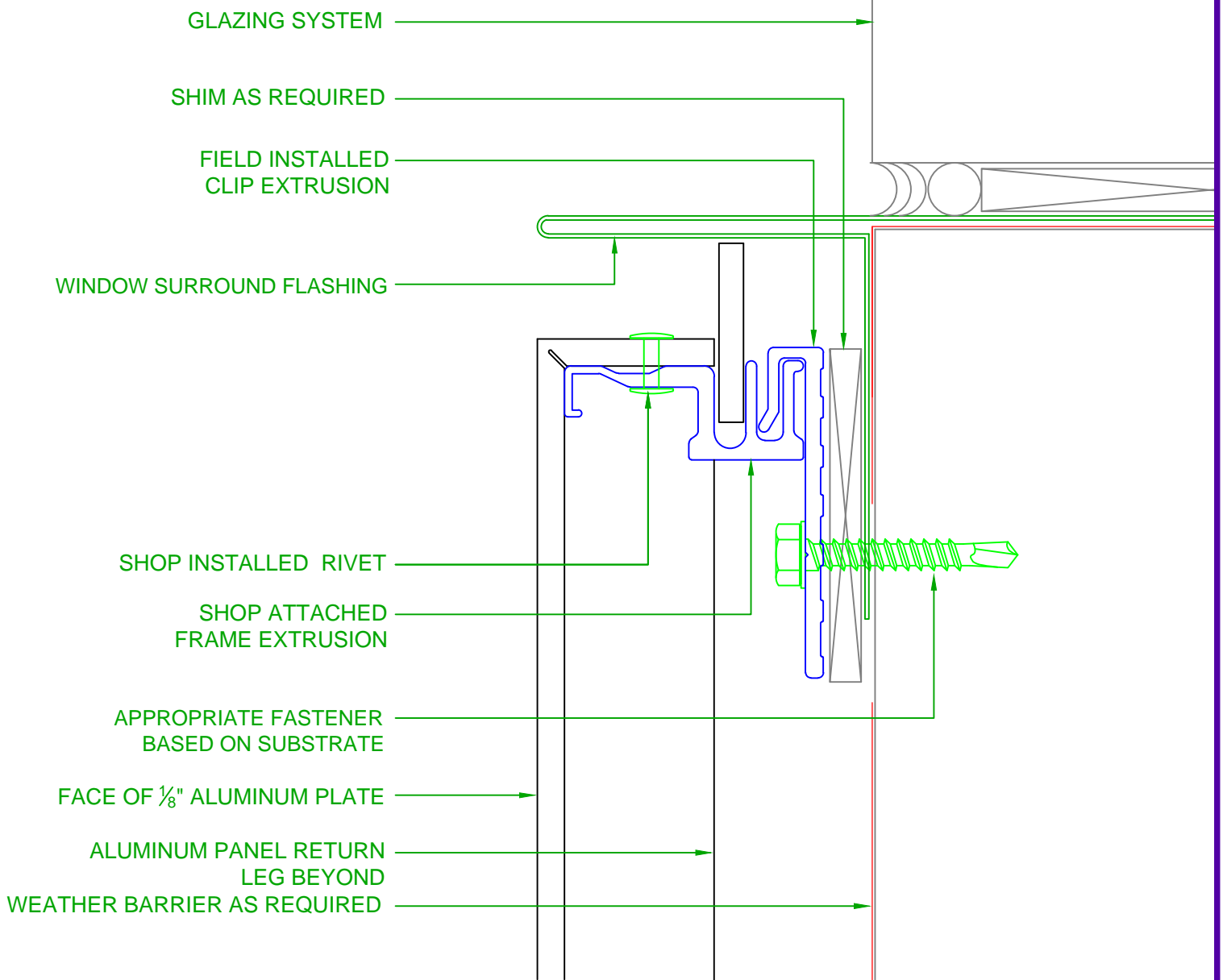

2529 W. Jackson St.
 Phoenix, AZ 85298
 PHONE: (602) 275-1676
 FAX: (602) 275-1739

TYP. WINDOW SURROUND DETAIL

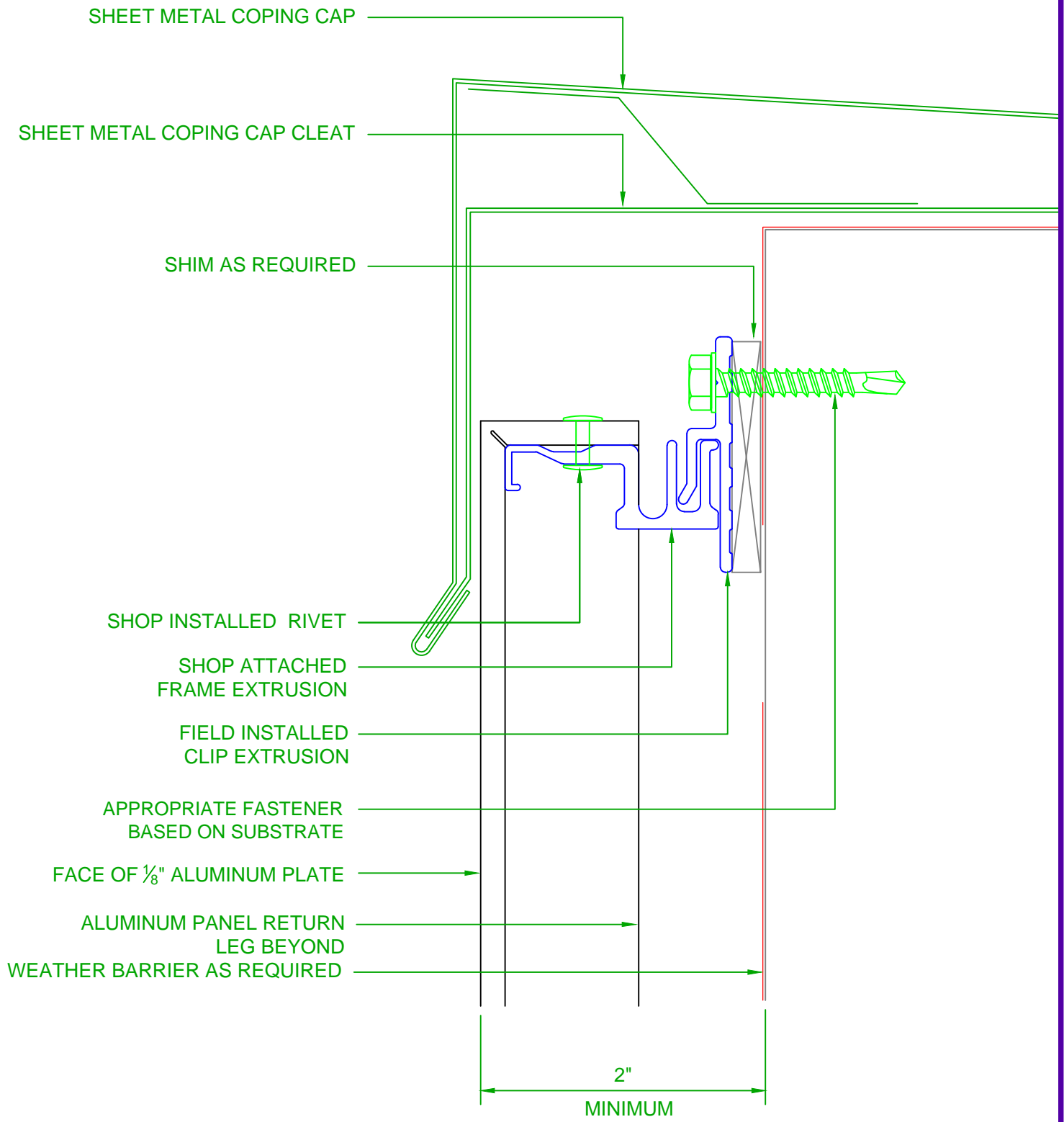

2529 W. Jackson St.
 Phoenix, AZ 85298
 PHONE: (602) 275-1676
 FAX: (602) 275-1739

SHEET METAL COPING CAP DETAIL

SCALE: NTS

7/24/14

SYSTEM = 1/8" ALUMINUM - AP400

TYP. ACM COPING CAP DETAIL

SYSTEM = 1/8" ALUMINUM - AP400

7/24/14

SCALE: NTS

2529 W. Jackson St.
Phoenix, AZ 85298
PHONE: (602) 275-1676
FAX: (602) 275-1739

