

Mosaic Alumaboard 1" x 5" L-Connect Batten

Product Information:

- Architectural Batten Profile for sunshades, pergolas, privacy screens, signage, decorative elements, soffits and siding, screen wall & fencing.
- Mechanically attach with internal fastening.
- Numerous attachment methods based on application.
- Light Texture Finishes: Solid colors, woodgrains and specialty finishes available
- Matching finish on rivet attached & press fit End Cap is available
- Extruded aluminum shape
- Paint finish testing: AAMA 2604
- Class "A" Fire Rating
- Standard profile length is 24'-0"
- Lengths less than 24'-0" available upon request
- See Batten Extrusion Line Card for other Components.

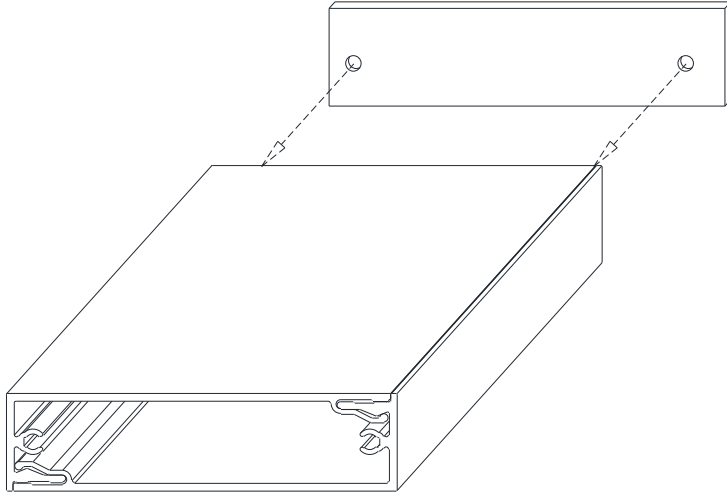

OPTION 1:
A: FASTEN TO SUBSTRATE.



OPTION 1:
B: SNAP BATTEN CAP ONTO BASE



OPTION 2:
B: SNAP BATTEN CAP ONTO BASE



OPTION 2:
A: FASTEN TO SUBSTRATE.

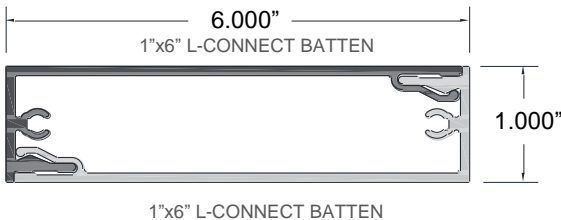

1" x 5" L-Connect Batten