



Lumabuilt

PRODUCT DATA SHEET 2" X 4" ARCHITECTURAL BATTEN ASSEMBLY

Mosaic
Planks and Battens

Product Name

Mosaic 2"x4" Architectural Batten Assembly

Manufacturer

Lumabuilt
Lumabuilt.com

Product Description

Mosaic Architectural Battens work beautifully as sunshades, grilles, privacy screens, signage, decorative elements, screen wall and fencing. The design capabilities are endless with the versatility of Mosaic. The product is lightweight, durable and our licensed proprietary sublimation process will make its low maintenance beauty last for years.

Finishes: Woodgrains, solid colors and specialty finishes available.

Installation

Mosaic batten assemblies attach with concealed or exposed fasteners. Matching finish on press fit End Caps are available. If using an end cap ensure you have designed your layout to accommodate an end cap install.

Technical Data

- Class "A" Fire Rating.
- Paint finish testing: AAMA 2605
- Extruded aluminum shape
- Standard profile length is 24'-0"
- Lengths less than 24'-0" available upon request
- Weight 1.532 pounds/LF
- See Batten Extrusion Line Card for additional components
- Tee shaped end cap offers no exposed fasteners
- Pre-punched end caps require fasteners to install
- Fully ICC Certified (ESR-5449)
- (ESR-5449) FL Supplement with HVHZ

Warranty

Wood grains 15 year standard warranty. Wood Grains 20 year specialty warranties on request. Solid Colors 20 year standard warranty. Refer to warranty form for full details.

Maintenance

To preserve the original beauty of Mosaic products a regular cleaning schedule is suggested. Clean the finish surface with water and a soft brush or sponge until it is free of debris. If required the finish surface may be also cleaned with a mild detergent (pH 6-7) or a cleaning agent diluted to 1:50 parts of water. Refer to cleaning instructions for full details.





Product Information

- Architectural Batten Profile for sunshades, grilles, privacy screens, signage, decorative elements, screen wall & fencing
- Mechanically attach with concealed or exposed fasteners
- Finishes: Solid colors, woodgrains and specialty finishes available
- Matching finish on press fit End Caps available
- Extruded aluminum shape
- Paint finish testing: AAMA2605
- Class "A" Fire Rating
- Standard profile length is 24'-0"
- Lengths less than 24'-0" available upon request
- See Batten Extrusion Line Card for other Components

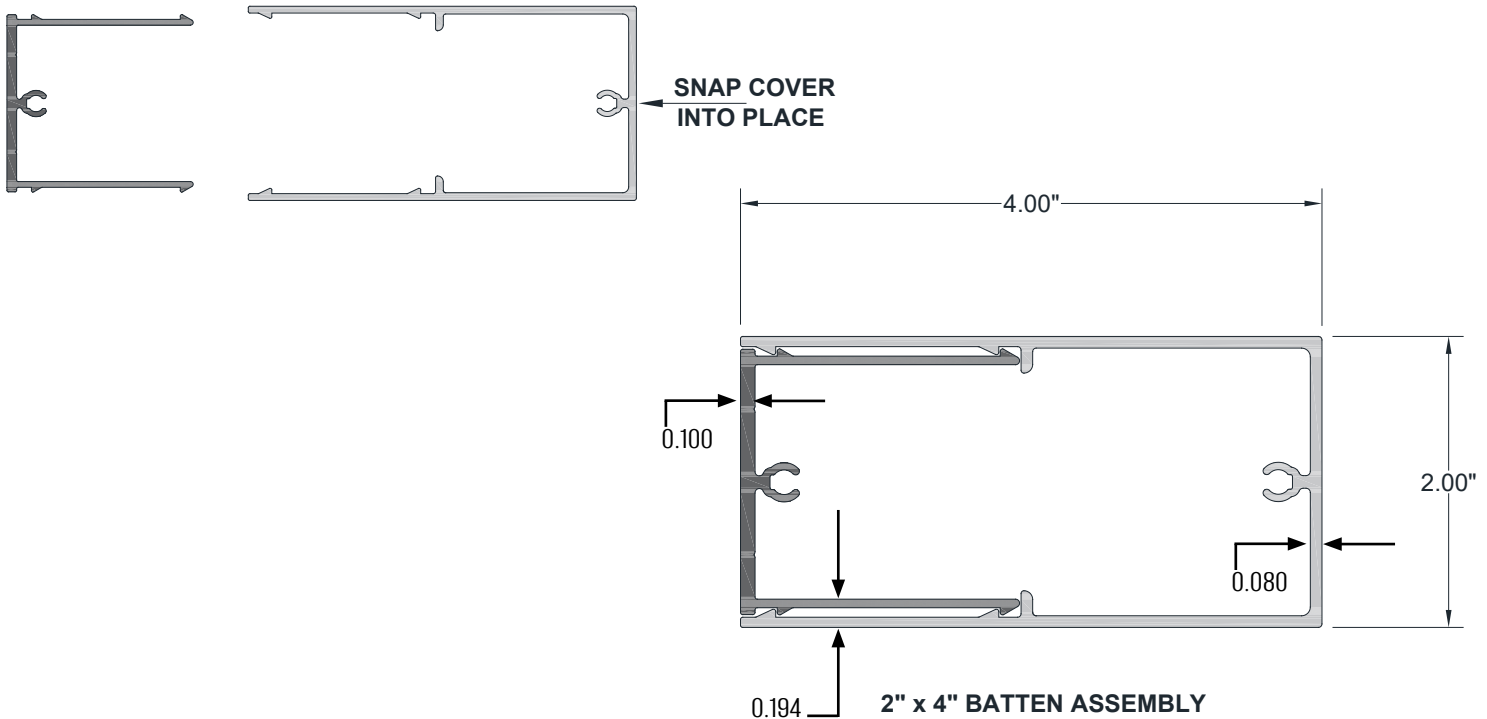

For additional information on Mosaic please visit us online at Lumabuilt.com



Approved
Continuing
Education

